

Standard Kit 20"

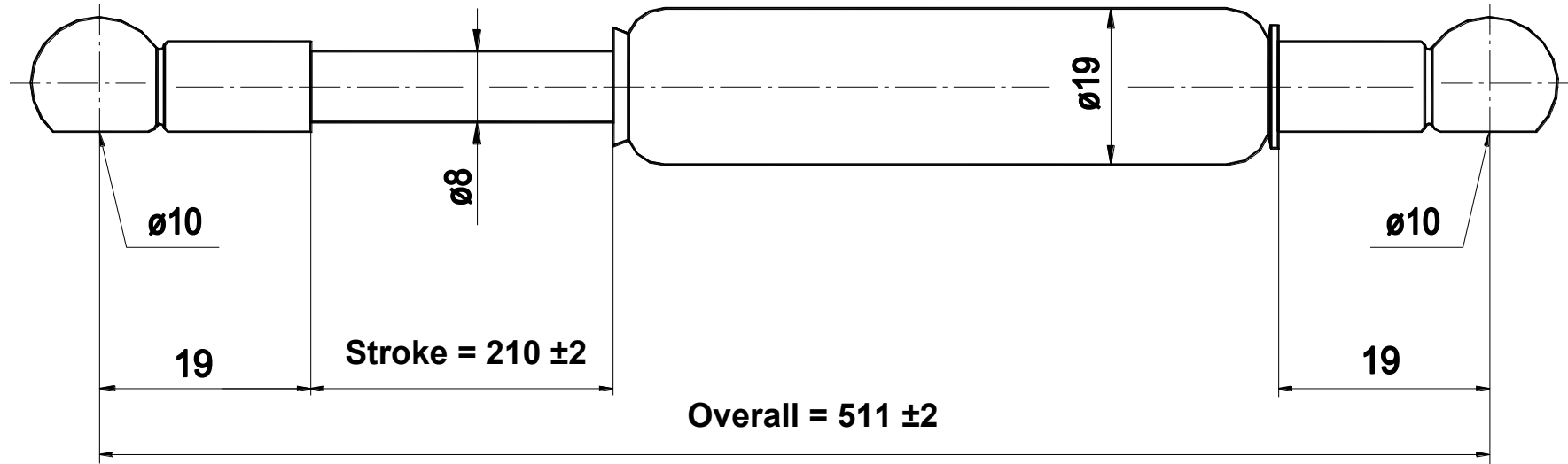

900BA3

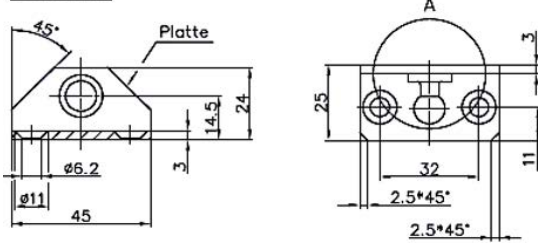

900BA4

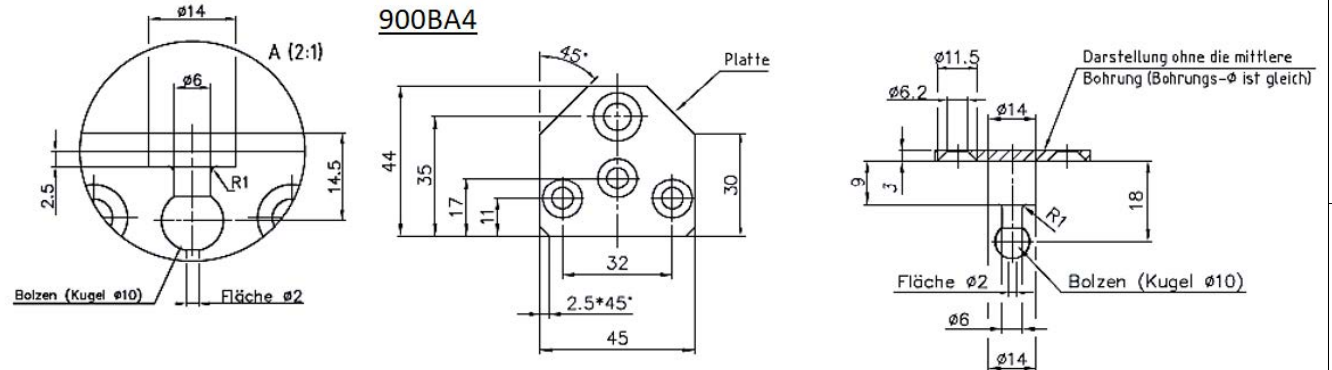

Notes:

- All dimensions shown in millimeters
- Piston rod must be protected against paint, dirt, and damage
- With valve in cylinder end
- Normal extension speed, increased end damping Extension force range: 10lbs to 150lbs (45N-670N)

Zeichnung nicht maßstäblich. Drawing not in scale.

Ohne unsere Genehmigung darf diese Zeichnung weder kopiert noch vervielfältigt noch dritten Personen oder Konkurrenzfirmen zugänglich gemacht werden. Paragraph und 17 des Gesetzes v.19.07.1901	Allgemein- toleranzen ISO 2768-m	Werkstück- konten DIN 6784	Maßstab % GF-KPKP	Bearbeitet: JP
	F3F3F50-210-511/XXXN			Bansbach easylift Bansbach easylift Postfach 1170 73541 Lorch/Württ. Dateiname Z2340