

Marine Stainless Kit 28"

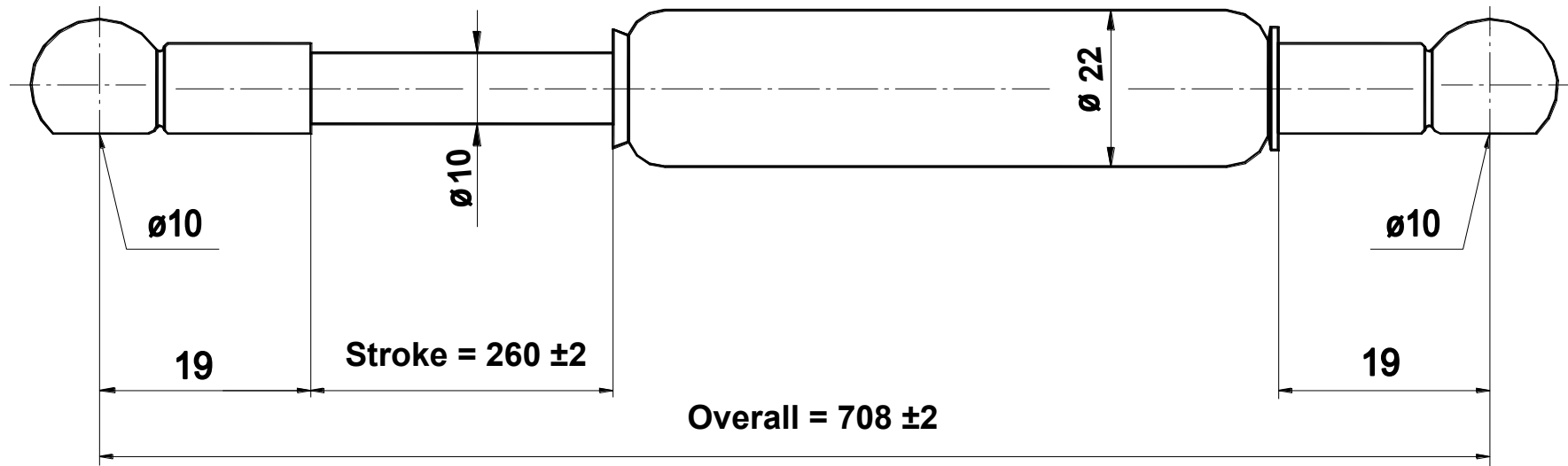

900BA3NISR (AISI 304 Stainless Steel)

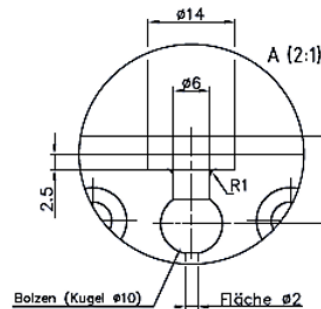
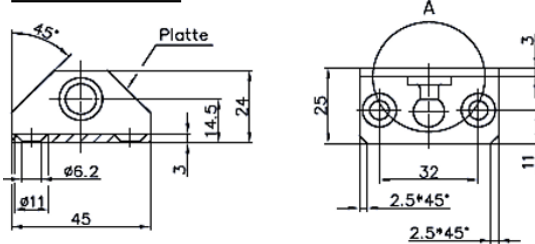

900BA4NISR (AISI 304 Stainless Steel)

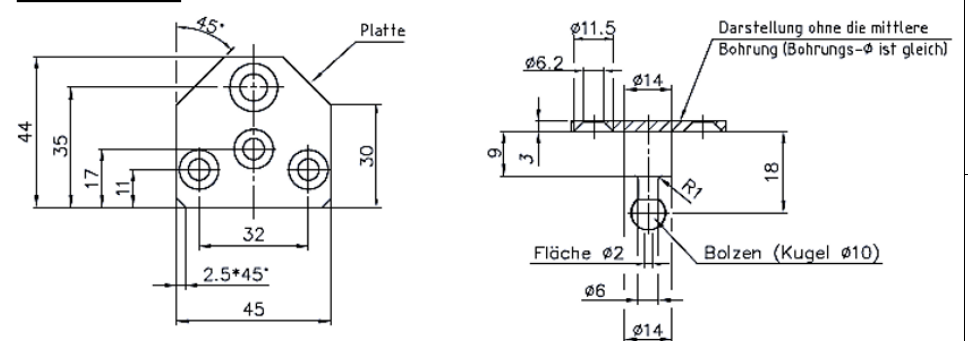

Notes:

- All dimensions shown in millimeters
- Piston rod must be protected against paint, dirt, and damage
- N= 316L Stainless Steel Gas Spring
- AISI 303 Stainless Steel end fittings
- Normal extension speed, increased end damping Extension force range: 15lbs to 290lbs (65N-1290N)

Zeichnung nicht maßstäblich. Drawing not in scale.

Ohne unsere Genehmigung darf diese Zeichnung weder kopiert noch vervielfältigt noch dritten Personen oder Konkurrenzfirmen zugänglich gemacht werden. Paragraph und 17 des Gesetzes v.19.07.1901	Allgemein- toleranzen ISO 2768-m	Werkstück- konten DIN 6784	Maßstab % GF-KPKP	Bearbeitet: JP
	F3F3N52-260-708/XXXXN			Bansbach easylift Bansbach easylift Postfach 1170 73541 Lorch/Württ. Dateiname Z2340